

# Fitting accessories

Our range of fitting accessories makes home installation easier and helps you achieve the right look.

## DIFFUSER VENTS

With the aim of providing solutions when metal inserts and fireplaces are fitted in completed buildings, we have created a range of diffuser vents that ensure proper convection-air inlet and outlet, i.e. the proper venting of the hearth, and help to integrate these components, which can be awkward to incorporate.



**D0000** Single air inlet diffuser vent

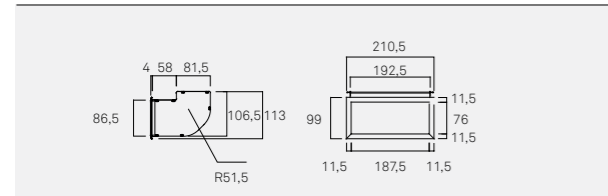

**D0002** Single air inlet diffuser vent narrow

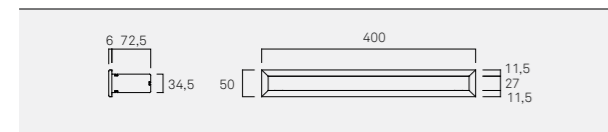

**D0005** Double air inlet diffuser vent

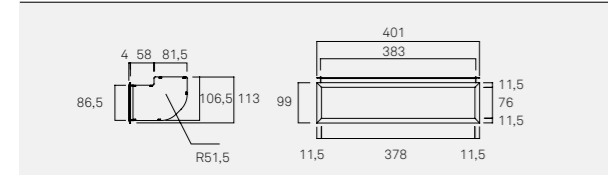

**D0007** Double air inlet diffuser vent narrow

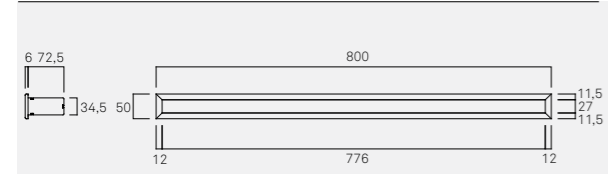

**D0010** Triple air inlet diffuser vent

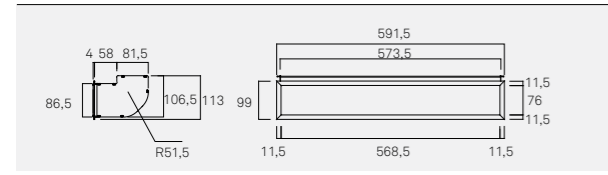

**D0015** Quadruple air inlet diffuser vent

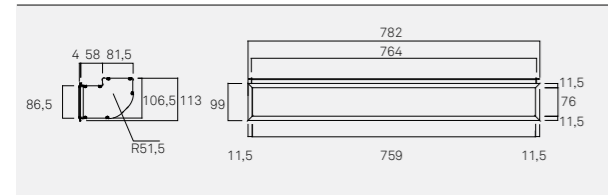

**D1000** Single air outlet diffuser vent

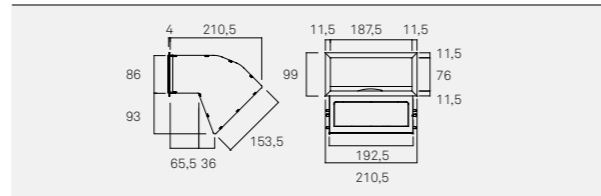

**D1002** Single air outlet diffuser vent narrow

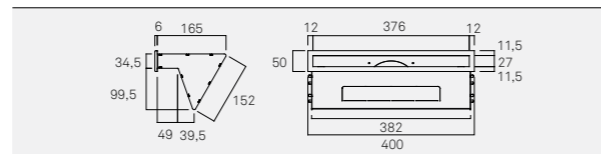

**D1005** Double air outlet diffuser vent

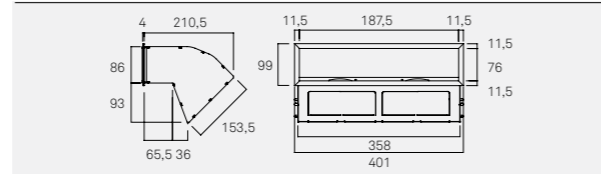

**D1007** Single air outlet diffuser vent narrow

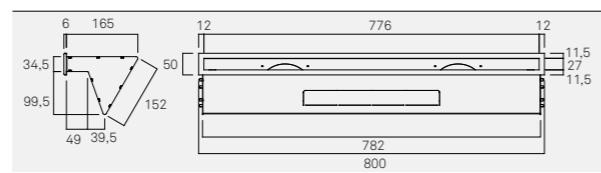

**D1010** Triple air outlet diffuser vent

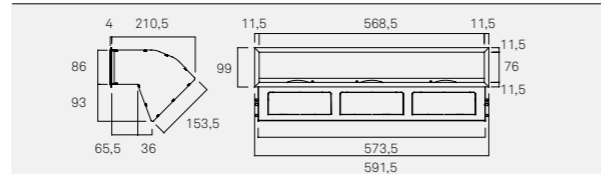

**D1015** Quadruple air outlet diffuser vent

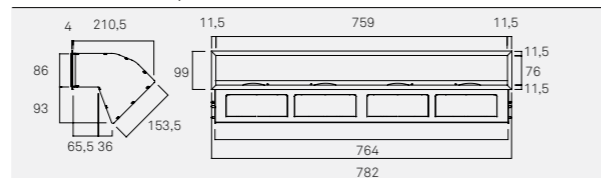

## LOG STORE

An ideal space for storing logs.

Cut-outs for three shelves and light in upper section.



**C1000** Wood store

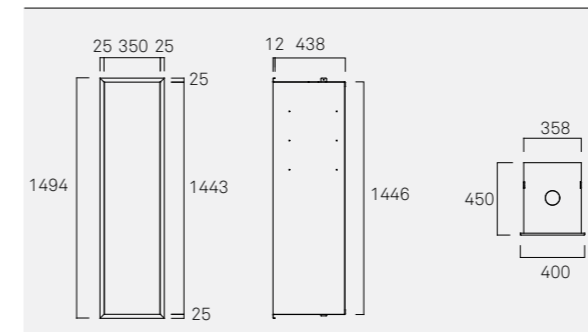

Diffuser vents, model G-30 LD

