

Complementos de montagem

A nossa gama de complementos para a montagem dos módulos ajudá-lo-á no momento da instalação e também a conseguir a estética desejada.

DIFUSORES

Com o intuito de proporcionar soluções ao instalar os módulos e os inserts numa obra fechada, criámos uma gama de difusores que asseguram uma correta entrada e saída do ar de convecção – isto é, uma correta ventilação da recâmara da lareira – conseguindo ao mesmo tempo integrar no conjunto estes elementos por vezes tão difíceis de combinar.

C4000 Difusor de entrada articulável

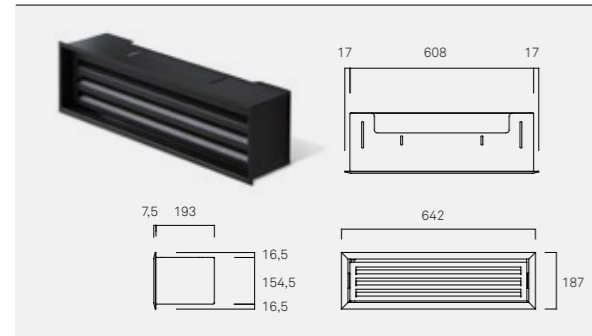

D0000 Difusor de entrada de ar simples

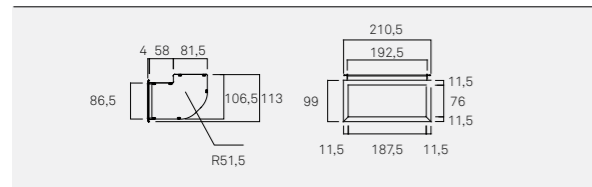

D1000 Difusor de saída de ar simples

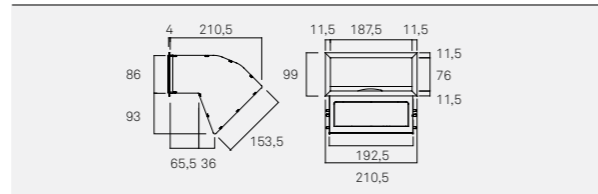

D0002 Difusor de entrada de ar simples

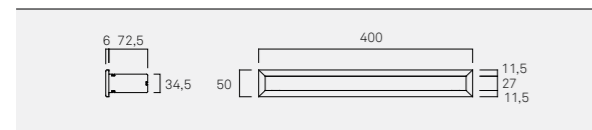

D1002 Difusor de saída de ar simples

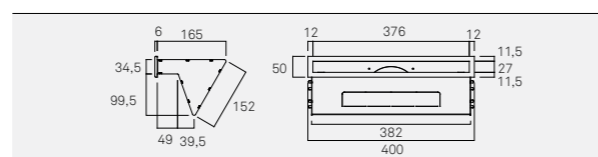

D0005 Difusor de entrada de ar dupla

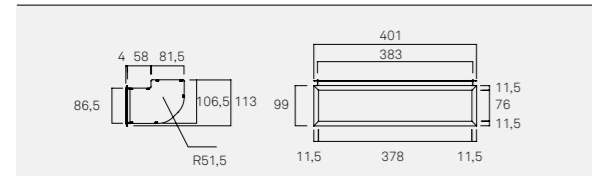

D1005 Difusor de saída de ar dupla

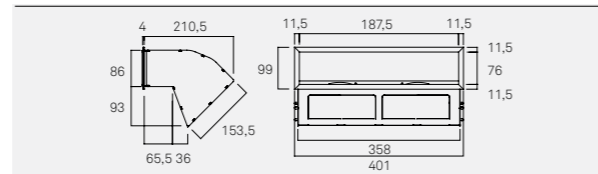

D0007 Difusor de entrada de ar dupla

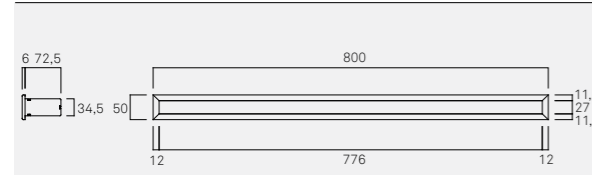

D1007 Difusor de saída de ar simples

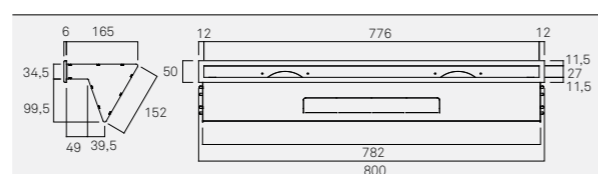

D0010 Difusor de entrada de ar tripla

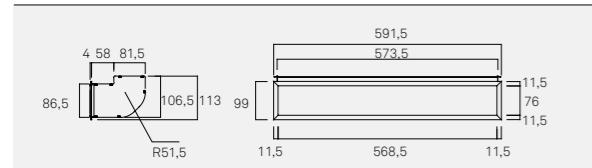

D1010 Difusor de saída de ar tripla

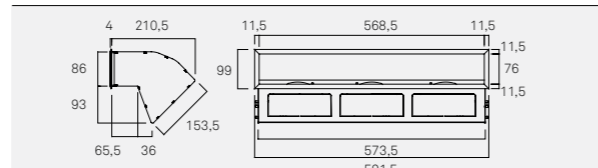

D0015 Difusor de entrada de ar quádrupla

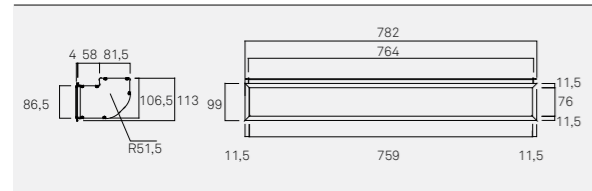

D1015 Difusor de saída de ar quádrupla

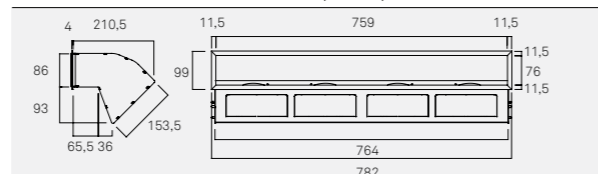

PORTA-LENHA

Espaço ideal para o armazenamento dos troncos.

Dispõe de cortes para instalação de três prateleiras e luz na parte superior.



Difusores com modelo G-30 LD



C1000 Porta-lenha.

